

Data Sheet



SCA830-D07 1-AXIS INCLINOMETER WITH DIGITAL SPI INTERFACE

Features

- 3.3V supply voltage
- ± 1 g measurement range
- Single axis measurement in Y direction
- ± 30 mg offset accuracy over temp range
- SPI digital interface
- Extensive self diagnostics features
- Size 7.6 x 3.3 x 8.6 mm (w x h x l)
- Qualified according to AEC-Q100 standard
- Package, pin-out and SPI protocol compatible with VTI digital accelerometer product family
- RoHS compliant Dual Flat Lead (DFL) plastic package suitable for lead free soldering process and SMD mounting
- Proven capacitive 3D-MEMS technology
- High resolution 16-bit A/D converter

Applications

The SCA830-D07 is targeted to applications with high stability requirements. Typical applications include

- Hill Start Aid (HSA)
- Electronic Parking Brake (EPB)
- Roll Over detection
- Suspension control
- Inclinometers
- Motion and position measurements

General Description

The SCA830-D07 is a single axis inclinometer component based on VTI's capacitive 3D-MEMS technology. The component integrates high accuracy micromechanical acceleration sensing together with a flexible SPI digital interface. Dual Flat Lead (DFL) housing guarantees reliable operation over product lifetime.

The SCA830-D07 is designed, manufactured and tested for high stability, reliability and quality requirements of automotive applications. The inclinometer has an extremely stable output over wide ranges of temperature, humidity and mechanical noise. The component is qualified to the AEC-Q100 standard and has several advanced self diagnostics features. The DFL housing is suitable for SMD mounting and the component is compatible with the RoHS and ELV directives.

The SCA830-D07 is a part of VTI's digital accelerometer family and fully compatible with its single axis accelerometers (SCA800 Series) and other multi axis accelerometers (SCA2100 Series and SCA3100 Series).

Performance Characteristics

Vdd=3.3 V and ambient temperature unless otherwise specified.

Parameter	Condition				Units
		Min	Typ ^{A)}	Max	
Analog and digital Vdd		3.0		3.6	V
Current consumption	Active mode		5	6.3	mA
	Power down mode			0.1	mA
Measurement range	Measurement axis (Y)	-1		1	g
		-90		+90	°
Operating temperature		-40		125	°C
Total offset error ^{B)}	Temperature range -40 ... +125 °C	-70		+70	mg
Offset stability ^{C)}	Temperature range -40 ... +125 °C	-25		25	mg °
Offset calibration error ^{D)}	@25°C		±20		mg °
			±1.1		
Offset temperature drift	Temperature range -40 ... +125 °C			30 ^{E)}	mg
Sensitivity	16 bit output between ±3°		32 000		Count/g
			0.00179		°/Count
Total sensitivity error	Temperature range -40 ... +125 °C	-4		4	% FS
Sensitivity calibration error	@25 °C ±5°C		±1.4		% FS
Sensitivity temperature drift	Temperature range -40 ... +125 °C		±0.9		% FS
Linearity error	+1g ... -1g range	-20		20	mg
Cross-Axis sensitivity			±2	±3.5	%
Zero acceleration output	2-complement		0		Counts
Amplitude response	-3dB frequency		6.25		Hz
Noise			0.15		mg RMS
Power on setup time				0.3	s
Output data rate			125		Hz
Output load				50	pF
SPI clock rate				8	MHz
ESD protection	Human Body Model			2	kV
	Charge Device Model			1	kV
Moisture sensitivity level	IPC/JEDEC J-STD-020C, Level 3				
Mechanical shock				20 000	g
ID register value	Customer readable ID register (27hex)		0A		

- A) Typical ± values are ±3 sigma variation limits from validation test population.
 B) Includes offset deviation from 0g value including calibration error and drift over lifetime, temperature and supply voltage.
 C) After mounting of the ECU to the application and after offset zero-setting at room temperature. Relevant offset failure due to temperature dependency of offset as well as aging over lifetime
 D) Includes offset deviation from 0g value including calibration error and drift over lifetime.
 E) Offset drift due to temperature. Value is a relative value and has been centered to zero. Error defined as maximum change of offset in temperature range. Offset (max)-Offset (Min). 100% tested in production.

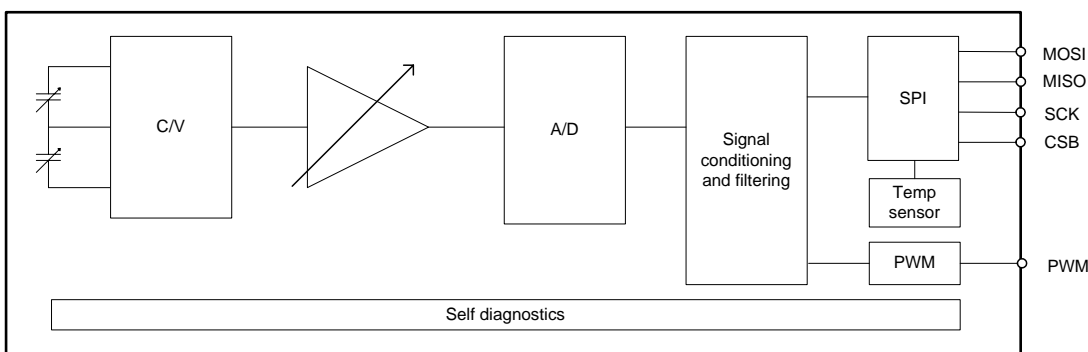
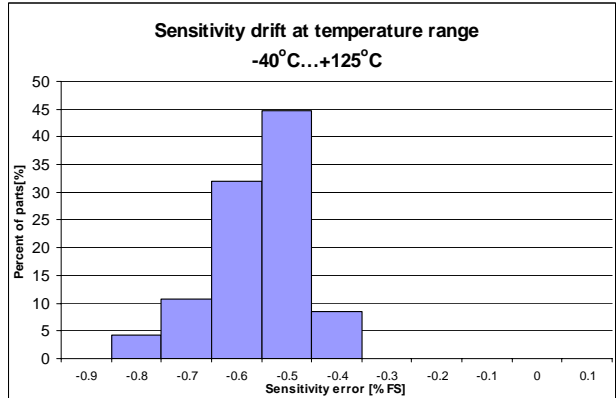
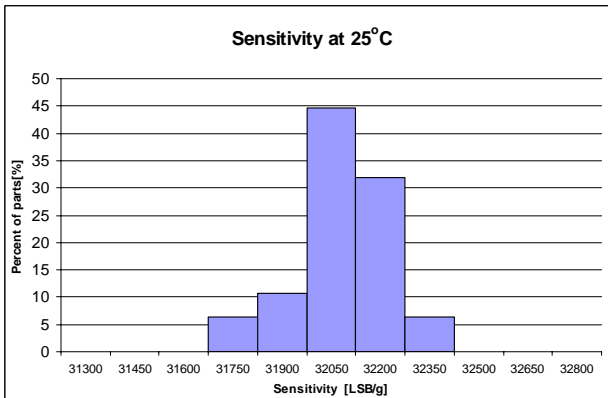
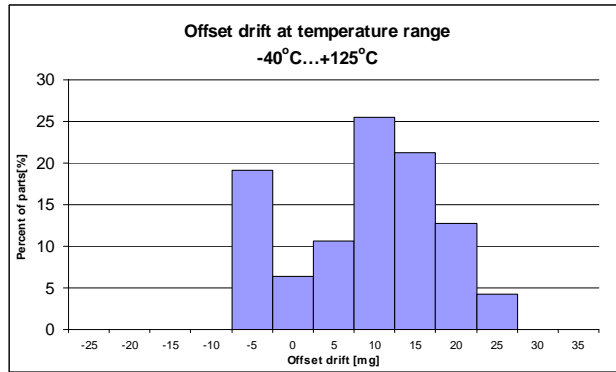
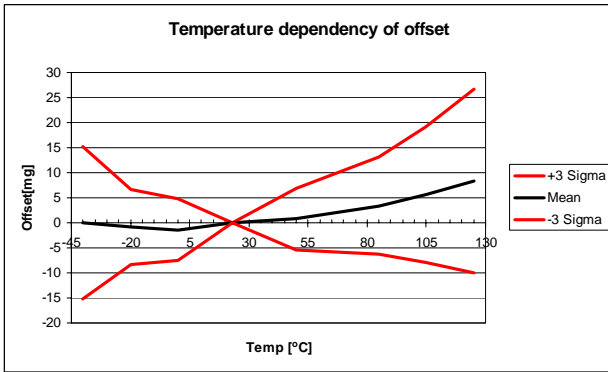
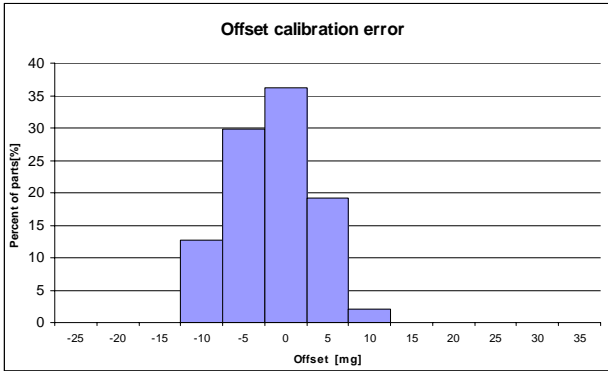

Figure 1. SCA830-D07 Block diagram

Typical Performance characteristics



Measurement directions

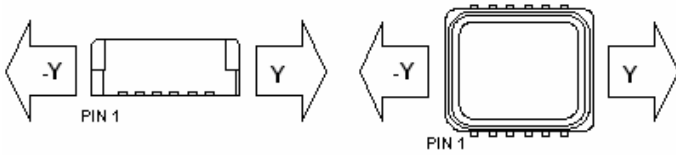

Figure 1. Accelerometer measuring directions

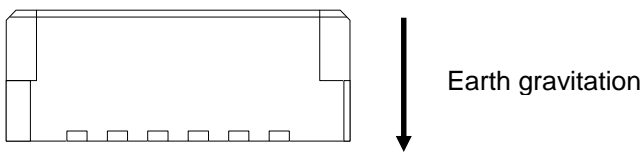

Figure 2. Zero acceleration output position

Housing dimensions

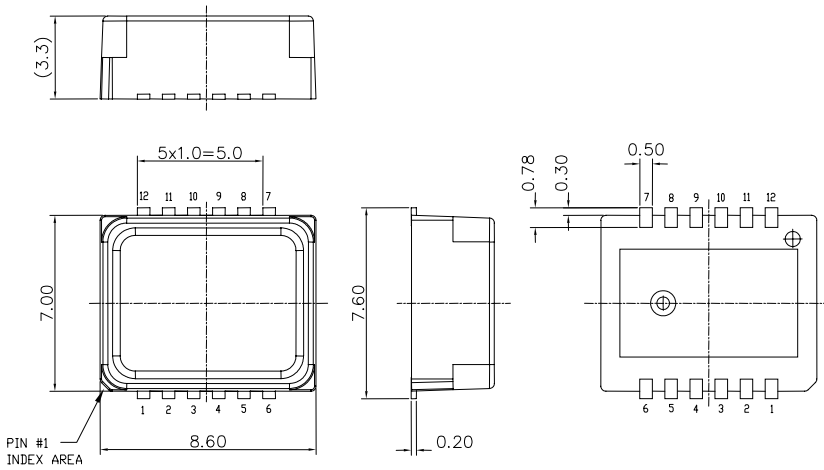

Figure 3. Housing dimensions

Application Note for Acceleration Output Reading (16 bit output sensitivity)

This is addition to SCA8X0_21X0_3100 Product Family Specification chapter 3.1.

DOUT_LSB

Address: 4h

Bits	Mode	Initial Value	Name	Description
7:0	R	00h	DATA	Acceleration data LSB frame Read always DOUT_MSB prior to DOUT_LSB.

DOUT_MSB

Address: 5h

Bits	Mode	Initial Value	Name	Description
7:0	R	00h	DATA	Acceleration data MSB frame Reading of this register latches DOUT_LSB.

The bit level description of acceleration data from DOUT_LSB ... DOUT_MSB registers is presented below. The acceleration data is presented in 2's complement format. At 0 g acceleration the output is ideally 0000h.

+/-1g product	DOUT MSB bits(7:0)								DOUT LSB bits(7:0)								16b	
	15	14	13	12	11	10	9	8	7	6	5	4	3	2	1	0	[-]	Bits (15:0)
SCA8xx	s	512,0	256,0	128,0	64,0	32,0	16,0	8,0	4,00	2,00	1,00	0,50	0,25	0,13	0,06	0,03	[mg]	[Dec]
+1g position	0	1	1	1	1	1	0	1	0	0	0	0	0	0	0	0	1000	32000
-1g position	1	0	0	0	0	0	1	1	0	0	0	0	0	0	0	0	-1000	-32000
+Full-scale	0	1	1	1	1	1	1	1	1	1	1	1	1	1	1	1	1023	32767
-Full-scale	1	0	0	0	0	0	0	0	0	0	0	0	0	0	0	0	-1024	-32768

s = sign bit

Acceleration bits can be converted to mg acceleration (Acc) using following equation

$$Acc[mg] = \frac{1}{32} \left[-s \cdot 2^{15} + b_{14} \cdot 2^{14} + b_{13} \cdot 2^{13} + b_{12} \cdot 2^{12} + b_{11} \cdot 2^{11} + b_{10} \cdot 2^{10} + b_9 \cdot 2^9 + b_8 \cdot 2^8 + b_7 \cdot 2^7 + b_6 \cdot 2^6 + b_5 \cdot 2^5 + b_4 \cdot 2^4 + b_3 \cdot 2^4 \right. \\ \left. + b_2 \cdot 2^3 + b_1 \cdot 2^1 + b_0 \right]$$

Contact Information

<p>Finland (head office) VTI Technologies Oy P.O. Box 27 Myllynkivenkuja 6 FI-01621 Vantaa Finland Tel. +358 9 879 181 Fax +358 9 8791 8791 E-mail: sales@vti.fi</p>	<p>Germany VTI Technologies Oy Branch Office Frankfurt Rennbahnstrasse 72-74 D-60528 Frankfurt am Main, Germany Tel. +49 69 6786 880 Fax +49 69 6786 8829 E-mail: sales.de@vti.fi</p>	<p>USA VTI Technologies, Inc. One Parklane Blvd. Suite 804 - East Tower Dearborn, MI 48126 USA Tel. +1 313 425 0850 Fax +1 313 425 0860 E-mail sales@vtitechnologies.com</p>
<p>Japan Akebono Brake Industry Co.,Ltd. 5-4-71 Higashi, Hanyu-city Saitama Pref., 348-8501 Japan Tel. +81 48 560 1470 Fax +81 48 560 1469 www.akebono-brake.co.jp E-mail: forename.surname@vti.fi</p>	<p>China VTI Technologies Shanghai Office 6th floor, Room 618 780 Cailun Lu Pudong New Area 201203 Shanghai P.R. China Tel. +86 21 5132 0418 or +86 21 5132 0400 *112 Fax +86 21 513 20 416 E-mail: forename.surname@vti.fi</p>	<p>To find out your local sales representative visit www.vti.fi</p>